



# WatchGuard AP320

## Hardware Guide

---

## Copyright and Patent Information

Copyright© 2019 WatchGuard Technologies, Inc. All rights reserved.

WatchGuard, the WatchGuard logo, LiveSecurity, and any other mark listed as a trademark in the “Terms of Use” portion of the WatchGuard Web site that is used herein are either registered trademarks or trademarks of WatchGuard Technologies, Inc. and/or its subsidiaries in the United States and/or other countries. All other trademarks are the property of their respective owners.

Printed in the United States of America.

Revised: November 21, 2019

Companies, names, and data used in examples herein are fictitious unless otherwise noted. No part of this guide may be reproduced or transmitted in any form or by any means, electronic or mechanical, for any purpose, without the express written permission of WatchGuard Technologies, Inc.

Complete copyright, trademark, patent, and licensing information can be found in the WatchGuard product documentation. You can find this document online at:

<https://www.watchguard.com/help>

---

## ABOUT WATCHGUARD

WatchGuard® Technologies, Inc. is a global leader in network security, providing best-in-class Unified Threat Management, Next Generation Firewall, secure Wi-Fi, and network intelligence products and services to more than 75,000 customers worldwide. The company's mission is to make enterprise-grade security accessible to companies of all types and sizes through simplicity, making WatchGuard an ideal solution for Distributed Enterprises and SMBs. WatchGuard is headquartered in Seattle, Washington, with offices throughout North America, Europe, Asia Pacific, and Latin America. To learn more, visit [WatchGuard.com](http://WatchGuard.com).

For additional information, promotions and updates, follow WatchGuard on Twitter, @WatchGuard on Facebook, or on the LinkedIn Company page. Also, visit our InfoSec blog, Secplicity, for real-time information about the latest threats and how to cope with them at [www.secplicity.org](http://www.secplicity.org).

### ADDRESS

505 Fifth Avenue South  
Suite 500  
Seattle, WA 98104

### SUPPORT

[www.watchguard.com/support](http://www.watchguard.com/support)  
U.S. and Canada +877.232.3531  
All Other Countries +1.206.521.3575

### SALES

U.S. and Canada +1.800.734.9905  
All Other Countries +1.206.613.0895

# Hardware Specifications

---

The WatchGuard® AP family of wireless access points provide secure, reliable, wireless communications while delivering high performance and broad coverage—a perfect combination of services to meet the needs of enterprise-level customers, small businesses, branch offices, campuses, and hotels alike.

Internal antennas, slim cases, minimalist labeling, and small LEDs, coupled with wall and ceiling mount options, make these devices ideal for low profile deployment scenarios. Power can be provided by any Power over Ethernet (PoE) power source or an AC adapter.

WatchGuard AP320 devices features concurrent 3x3 MIMO capability and a dual radio that supports 2.4GHz (802.11b/g/n) and 5GHz (11a/n/ac) to provide wireless clients with enhanced reliability and performance.

There are two ways you can manage your AP320 device:

**Total Wi-Fi and Secure Wi-Fi with WatchGuard Wi-Fi Cloud**

A powerful cloud-based enterprise wireless management solution for AP configuration, security, and monitoring.

**Basic Wi-Fi with WatchGuard Firebox Gateway Wireless Controller**

Local management, configuration, security, and monitoring of APs directly from your WatchGuard Firebox. The WatchGuard Firebox requires Fireware v11.11.2 and higher.

For more information about how to set up and manage your WatchGuard AP, you can find documentation online at: <https://www.watchguard.com/help>

## Package Contents

---

- WatchGuard AP
- Quick Start Guide
- Wall-mount and T-rail ceiling-mount accessories



---

Optional mounting accessories for walls or ceilings without a T-rail are also available from WatchGuard. (Part #: WG8019)

---

# About Your Hardware

## Hardware Specifications

AP320	
<b>Radio Type and Frequency Band</b>	2.4GHz, 802.11b/g/n. Max data rate: 450 Mbps 5GHz, 802.11a/n/ac. Max data rate: 1.3 Gbps
<b>Antenna</b>	Six integrated omnidirectional antennas
<b>Ethernet interface</b>	1 x 10/100/1000 Mbps Gigabit Ethernet (LAN1) 802.3af PoE, PoE input voltage: 48V  1 x 10/100/1000 Mbps Gigabit Ethernet (LAN2) for a wired extension.  1 x RJ45 serial console, RS 232 Serial Bits per second: 115200 Data Bits: 8, Stop Bits: 1 Parity: None, Flow Control: None
<b>USB Port</b>	1 USB port (Not in use)
<b>Power Interface</b>	PoE: DC48v (802.3af) DC jack (12V DC input)
<b>Power Consumption</b>	Idle: <8W Peak: 13.104W Average: 12.04W
<b>Dimensions</b>	177mm x 155mm x 42mm
<b>Weight</b>	0.82 lb. (0.37 kg)

## Environmental Requirements

To safely install your WatchGuard AP, we recommend that you:

- Install the device indoors.
- Make sure the device has adequate clearance for air flow and cooling.
- Connect it to a surge-protected power supply to prevent damage from sudden power changes

Other environmental requirements:

Operating temperature	0°C to 40°C (32°F to 104°F)
Operating relative humidity	5% to 95% non-condensing
Non-operating temperature	-40°C to 70°C (-40°F to 158°F)
Non-operating relative humidity	5% to 95% non-condensing

# Hardware Description

## Device Connections and Buttons

### Ethernet Network Interfaces

LAN1: Standard RJ45 connector that supports link speeds of 10/100/1000 Mbps and PoE connectivity.

LAN2: Standard RJ45 connector that supports link speeds of 10/100/1000 Mbps.

This interface can be used as a wired extension for a wireless SSID that has NAT enabled. For more information on how to configure NAT settings for an SSID, see the *WatchGuard Wi-Fi Cloud Help*.

For APs managed locally by a Gateway Wireless Controller with Fireware v12.2.1 and higher, you can bridge together the LAN ports on AP models that have two LAN interfaces. This enables you to extend the wired network on the second LAN interface. For more information, see the *Fireware Help*.

CONSOLE: Standard RJ45 connector for serial console access.

### Power Input

The WatchGuard AP320 can be powered by an 802.3af PoE of nominal input voltage 48v DC on the LAN1 interface.

You can also power the device with an optional AC power adapter. Make sure you use only an AC power adapter supported by the AP320 device.

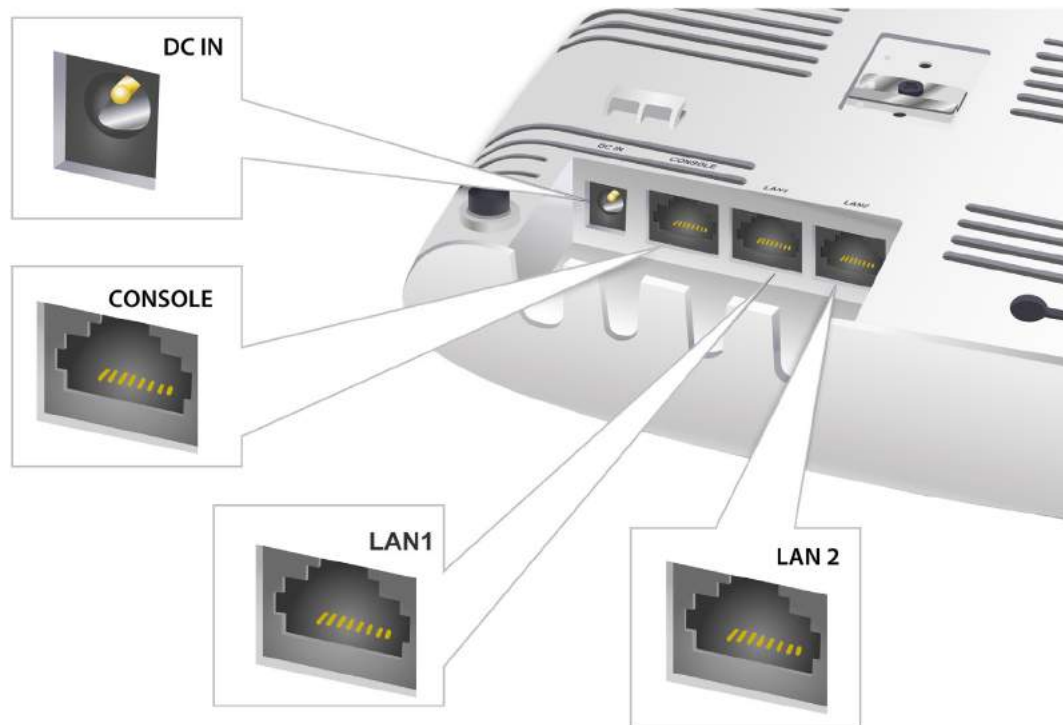

### Reset Button

Resets the WatchGuard AP to factory-default settings. You must use a paper clip or other small object to press the reset button through the small hole on the back of the device.

To reset the device to factory-default settings, power cycle the device (remove the power cable and reconnect it again). While you reconnect the power source, press and hold the reset button for at least 60 seconds until the power, LAN1, and 2.4 GHz indicators are green.

### USB Port

The USB port is currently not in use.

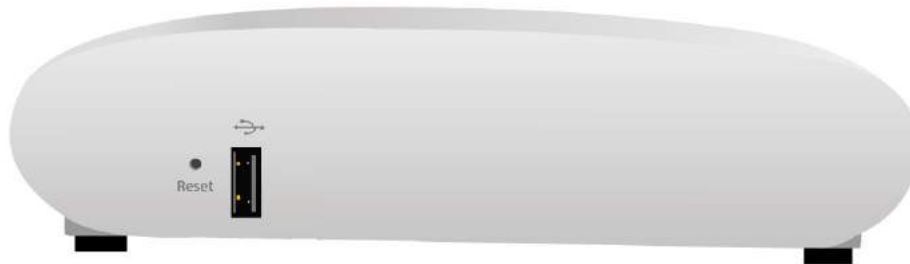

## Device Indicators

The front of the AP320 has these status indicators:



### AP Firmware 8.8.1 and Higher

LED Status	Power	LAN 1 and LAN2	2.4 GHz and 5 GHz Radios
Off	Powered off.	No Ethernet link.	Radio inactive.
Green	Powered on. Operating at normal power and capabilities. (PoE+ or DC power, or PoE for 802.3af only APs)	Connected at 10/100/1000 Mbps.	Radio active.
Flashing Green	Not connected to Wi-Fi Cloud or paired with a Gateway Wireless Controller.	-	-
Orange	Powered on. Operating at reduced power and capabilities. (For example: PoE 802.3af on PoE+ 802.3at capable APs). See <a href="#">AP Power Requirements</a> .	-	-
Flashing Orange	No IP address received from DHCP.	-	-

### AP Firmware 8.8.0 and Lower

#### Device Indicators in AP Mode

Power	LAN1	LAN2	2.4 GHz	5 GHz	Description
Solid green	Solid green	On/Off	Any	Any	Powered on and operating correctly. Connected to WatchGuard Wi-Fi Cloud services.
Solid green	Slow flash	On/Off	Slow flash	Any	Software upgrade in progress.
Solid amber	Solid green	On/Off	Any	Any	No Ethernet link.
Solid amber	Fast flash	On/Off	Any	Any	Did not receive a valid IP address from DHCP.
Solid amber	Slow flash	On/Off	Any	Any	Cannot connect to WatchGuard Wi-Fi Cloud services.
Off	Off	Off	Off	Off	Not powered on or in startup process.



If the Ethernet connection for an AP320 device drops down to 10/100 Mbps, the amber indicator for LAN1 will flash while the green indicator for LAN1 remains in its original state. The amber indicator for LAN1 may continue to flash even if the Ethernet connection switches back to 10/1000 Mbps mode. These indicators return to normal operation after you restart the AP.



### Device Indicators in WIPS Sensor Mode

These indicators are active when the AP is set to dedicated WIPS (Wireless Intrusion Prevention System) mode. For more information about WIPS mode, see the WatchGuard Wi-Fi Cloud help.

Power	LAN1	LAN2	2.4 GHz	5 GHz	Description
Solid green	Solid green	On/Off	Solid green	Solid green	Powered on and operating correctly. Connected to WatchGuard Wi-Fi cloud services.
Solid green	Solid green	On/Off	Solid green	Fast flash	Troubleshooting in progress on 802.11a/b/g/n.
Solid green	Solid green	On/Off	Solid green	Slow flash	Intrusion prevention in progress on 802.11a/n/ac.
Solid green	Slow flash	On/Off	Slow flash	Off	Software upgrade in process.
Solid amber	Solid green	On/Off	Any	Any	No Ethernet link.
Solid amber	Fast flash	On/Off	Any	Any	Did not receive a valid IP address from DHCP.
Solid amber	Slow flash	On/Off	Any	Any	Cannot connect to WatchGuard Wi-Fi Cloud services.
Solid amber	Any	On/Off	Solid Green	Any	Error on 802.11a/b/g/n interfaces.
Solid amber	Any	On/Off	Any	Solid green	Sensor software error.
Off	Off	Off	Off	Off	Not powered on or in startup process.

## Mounting Instructions

---

Your package includes the AP320 device, and wall-mount and T-rail ceiling-mount accessories.



AP320



Ceiling-Mount Accessories



Wall-Mount Accessories

## Wall Mounting

To mount an AP320 device to a wall:

1. Affix the mounting screws to the wall.
2. Mount the AP on the screws.

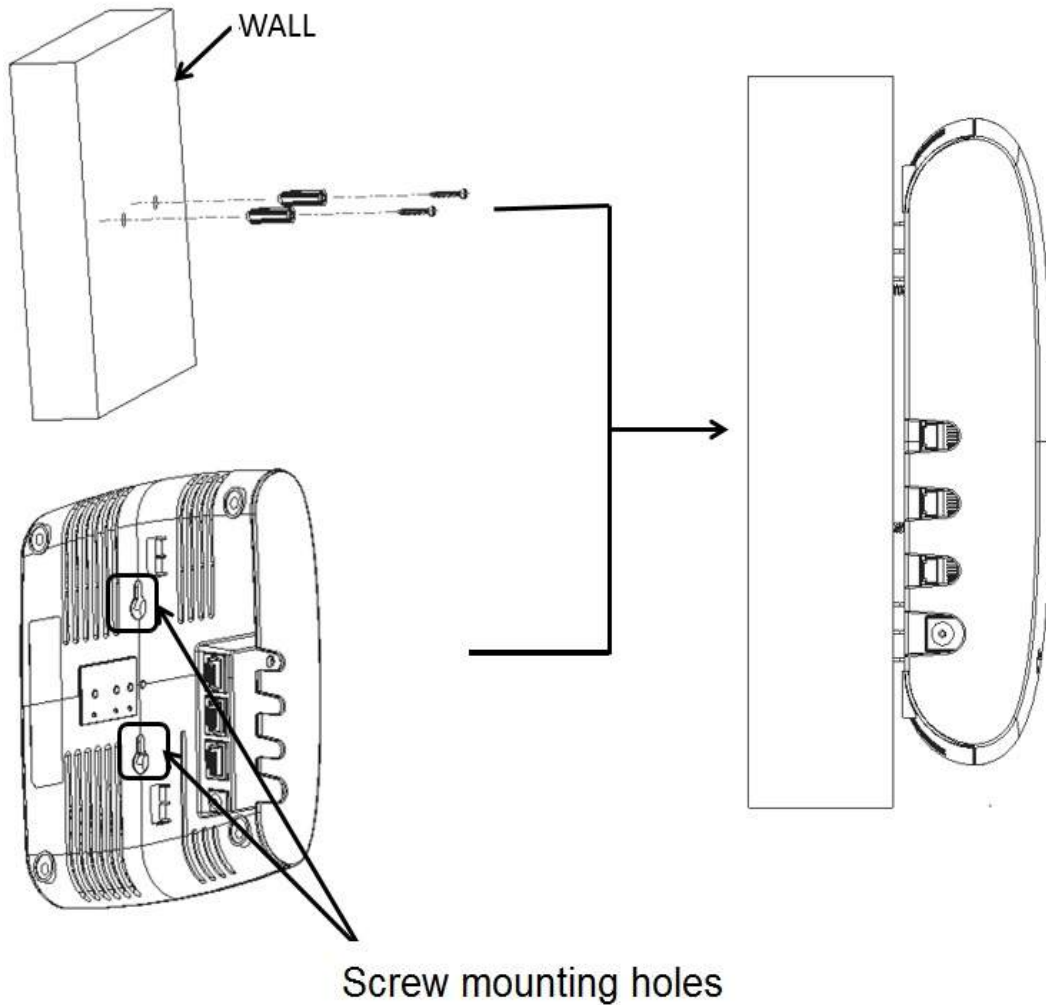

The MAC address and serial number of your AP are printed on a label on the back of the device. Make sure you record this information before you mount the AP.

## Ceiling Mounting

Use the supplied mounting bracket to install the AP320 on the ceiling with a T-rail.

To mount the device:

1. Attach the mounting bracket to the device.
2. Slide the device on to the T-rail affixed to the ceiling.

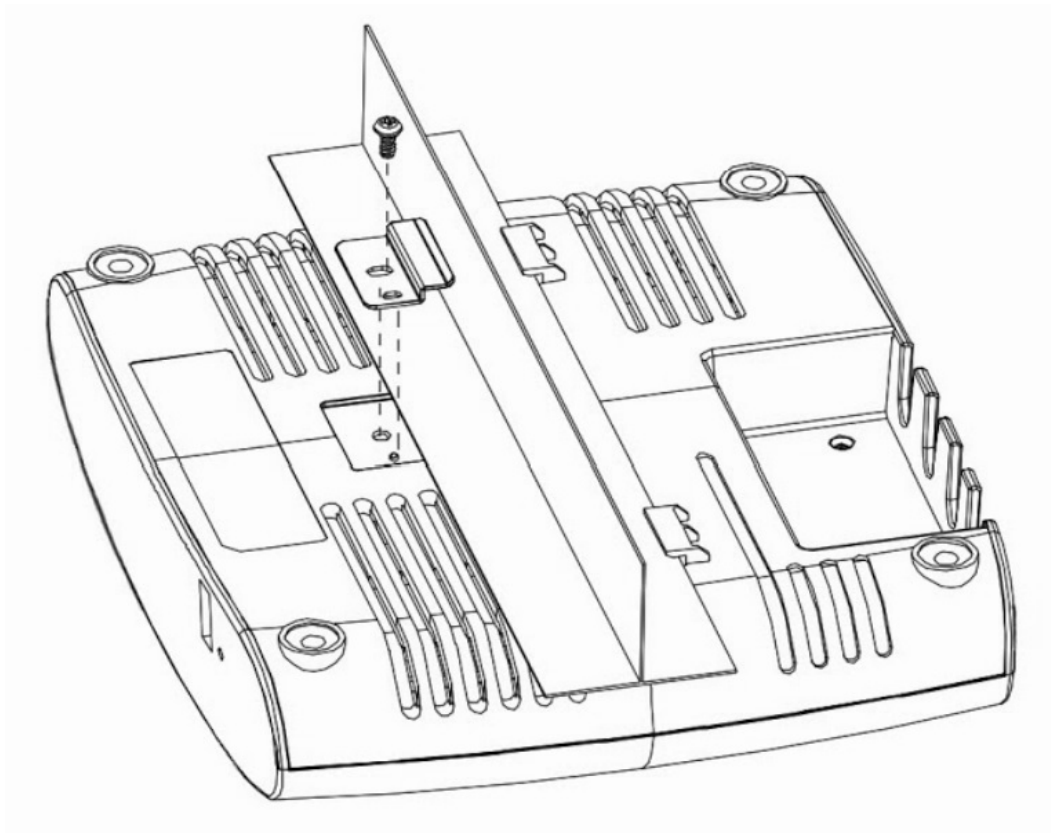

The MAC address and serial number of your AP are printed on a label on the back of the device. Make sure you record this information before you mount the AP.

---

## Optional Mounting Accessories

Optional mounting accessories for ceilings without a T-rail are also available from WatchGuard.  
(Part #: WG8019)

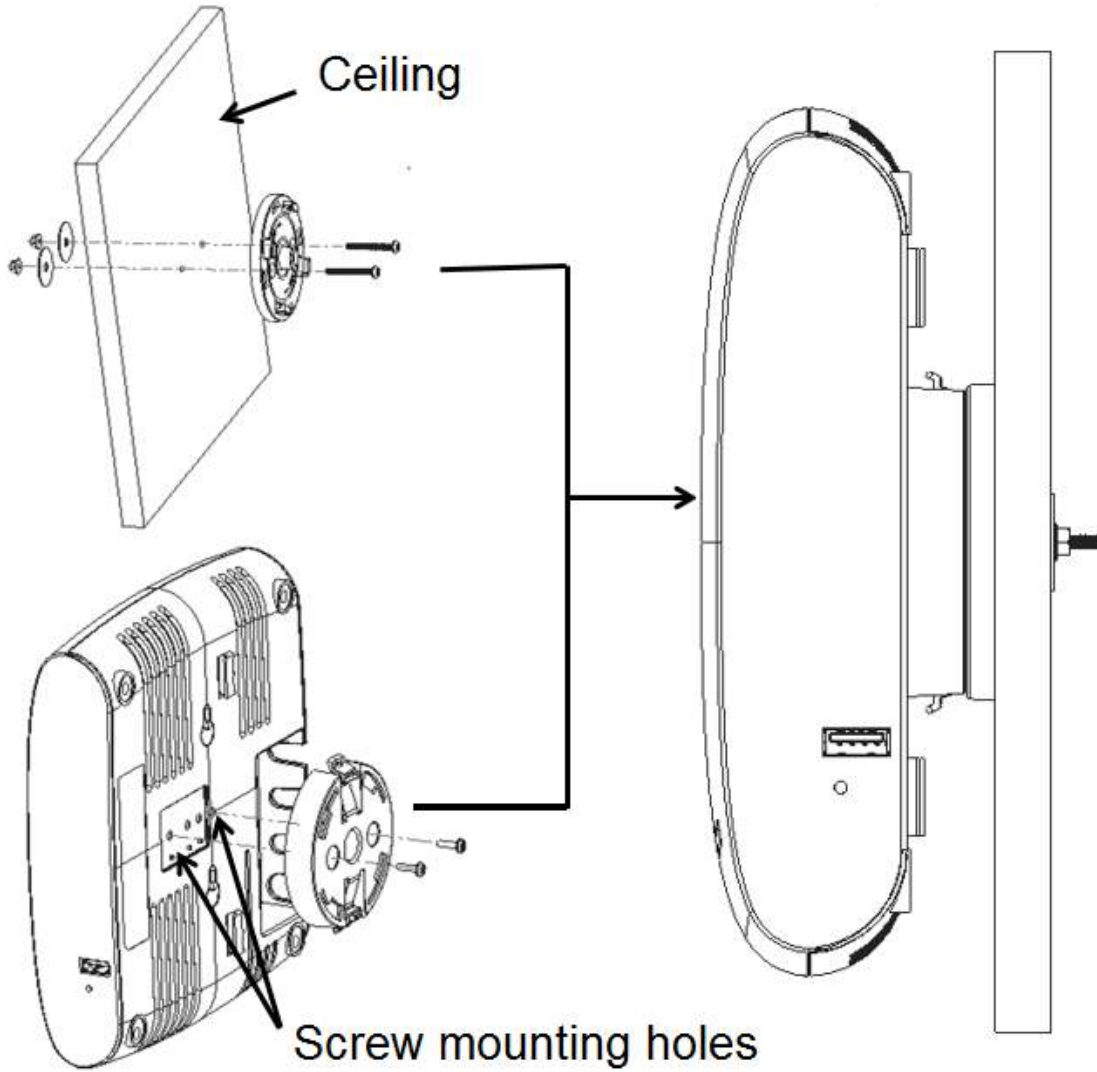

## Connect the AP

---

You can power the WatchGuard AP320 with an 802.3af PoE of nominal input voltage 48v DC. You can also power the device with an optional AC power adapter.

To power on and connect the AP320 to the network with PoE:

1. Connect one end of the network interface cable to the LAN1 port on the AP320.
2. Connect the other end of the network interface cable to an Ethernet jack that provides PoE power.

To connect the AP320 to the network and to power on the AP320 with a power adapter:

1. Connect one end of the network interface cable to the LAN1 port on the AP320.
2. Connect the other end of the network interface cable to an Ethernet network jack.
3. Plug the power adapter cable into the 12V DC power receptacle on the back of the AP320.
4. Plug the power adapter into an 110V-240V 50/60 Hz AC power source.

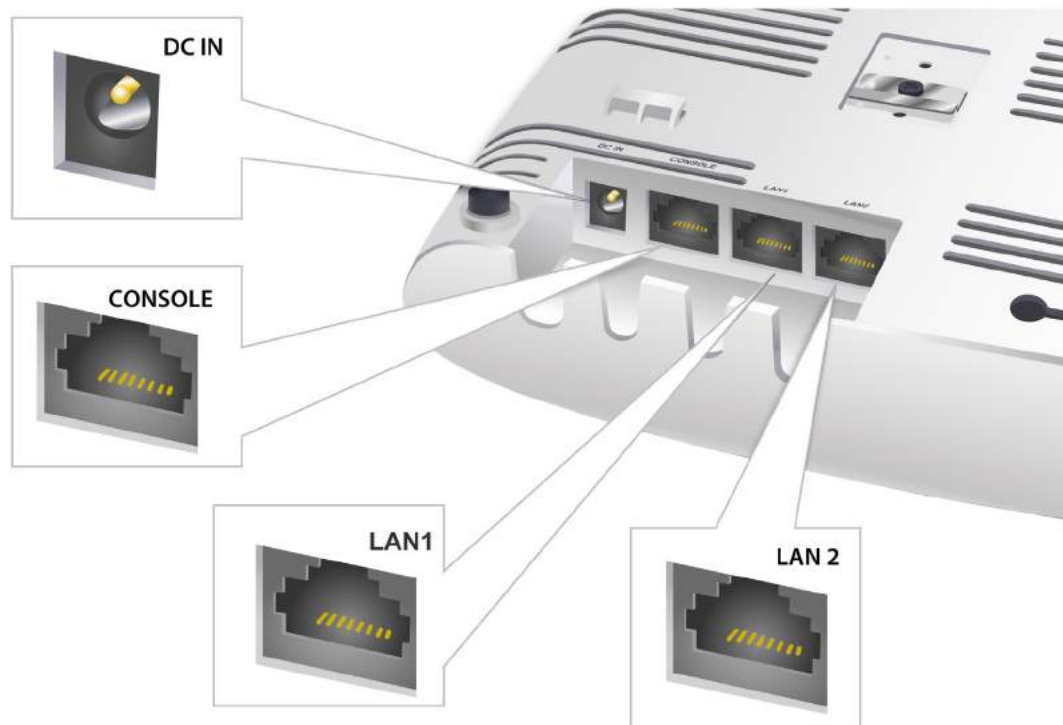

## AC Power Adapter (Optional)

An optional AC power adapter supplies 12V DC power to the WatchGuard AP and includes US, EU, UK, and AU region-specific adapter plugs.

### AC Power Adapter Specifications

AC Power Adaptor	
<b>WatchGuard Part #</b>	WG8016
<b>AC Input Voltage Rating</b>	90-264VAC
<b>Output Voltage</b>	DC12V, 1.5A
<b>Region-specific Adapter Plugs</b>	US, EU, UK, AU
<b>Temperature</b>	Operating: 0 to +40°C Storage: -20 to +85°C
<b>Humidity</b>	Operating: 0% to 95% Storage: 0% to 95%

## Ethernet Power Injector (Optional)

You can power the WatchGuard AP with an optional Ethernet Power Injector. This PoE/PoE+ capable device allows you to power the WatchGuard AP through an existing Ethernet connection. With this feature, you do not have to position your WatchGuard AP near a power outlet.



This device complies with IEEE 802.3at/af PoE specifications. Do not use any PoE adapters that are not IEEE 802.3at/af compliant as they may damage your device.

---

### Connect the Ethernet Power Injector

To connect an Ethernet Power Injector to the WatchGuard AP:

1. Plug the Ethernet Power Injector into an AC power source.
2. Connect an Ethernet cable from your network backbone (for example, a router, switch, or hub) to the **LAN** connector on the Ethernet Power Injector.
3. Connect an Ethernet cable from the PoE Ethernet interface on the AP to the **PoE** connector on the Ethernet Power Injector.



## Ethernet Power Injector Specifications

Ethernet Power Injector	
<b>WatchGuard Part #</b>	802.3at PoE+ Injector with AC cord (US/FCC) WG8599) 802.3at PoE+ Injector with AC cord (CE) WG8600) 802.3at PoE+ Injector with AC cord (UK) WG8601) 802.3at PoE+ Injector with AC cord (AUS) WG8602)
<b>Specification</b>	IEEE 802.3at/af
<b>AC Input Voltage Rating</b>	100 to 240VAC
<b>Input Current</b>	0.8A Max for 100VAC
<b>Output Power</b>	30W maximum
<b>Ethernet Interfaces</b>	LAN: RJ-45 for 10/100/1000 Mbps data POE: RJ-45 for 10/100/1000 Mbps data and power Voltage: Pin4, 5:54V, Pin7, 8:Return
<b>Indicator</b>	Power: Green
<b>Temperature</b>	Operating: 32°F to 104°F (0°C to 40°C) Storage: -22°F to 176°F (-30°C to 80°C)
<b>Humidity</b>	5 to 90% (Operating and storage)
<b>Dimensions</b>	L = 3.9" (99 mm) W = 2.27" (68.5 mm) H = 1.3" (33 mm)
<b>Weight</b>	0.33 lbs (149.6 g)

## Safety Notices

---

All WatchGuard products are designed and tested to meet strict safety requirements. These requirements include product safety approvals and other global compliance standards. Read these instructions carefully before you operate the product, and refer to them as needed for continued safe operation of your product.

### Product Safety Certification

The WatchGuard product is safety certified under the following standards:

- IEC 60950-1:2005 (Second Edition)+Am 1:2009+Am 2:2013
- EN 60950-1:2006+A11+A1+A12+A2:2013
- EN 61000-3-2:2006+A1:2009+A2:2009
- EN 61000-3-3:2008

### Safety Warning

- Do not place objects on the power cord.
- Do not obstruct the ventilation openings. These openings prevent overheating of the machine.
- Never push objects of any kind into slots or openings on this equipment. Making a contact with a voltage point or shorting out a part may result in fire or electrical shock.
- When removing or installing an appliance, follow the general installation safety instructions.

### Disclaimer

WatchGuard shall not be held liable if the end user alters, modify, or repairs any WatchGuard hardware appliance.

## HINWEISE ZUR SICHERHEIT

Alle WatchGuard Produkte werden entwickelt und getestet, um strenge Sicherheitsanforderungen zu erfüllen. Diese Anforderungen umfassen Produktsicherheit Zulassungen und andere globale Compliance-Standards. Bitte lesen Sie die folgenden Anweisungen sorgfältig, bevor Sie das Produkt, und bezeichnen sie als notwendig, um den sicheren Betrieb des Geräts zu gewährleisten. Weitere Informationen finden Sie in der elektronischen Hardware Guide.

Die WatchGuard Produkt ist Sicherheit unter den folgenden Normen zertifiziert:

- IEC 60950-1:2005 (Second Edition)+Am 1:2009+Am 2:2013
- EN 60950-1:2006+A11+A1+A12+A2:2013
- EN 61000-3-2:2006+A1:2009+A2:2009
- EN 61000-3-3:2008

Sicherheitshinweis

- Legen Sie keine Gegenstände auf das Netzkabel.
- Verdecken Sie nicht die Lüftungsöffnungen. Diese Öffnungen verhindern eine Überhitzung der Maschine.
- Stecken Sie niemals Gegenstände jeglicher Art in die Schlitze oder Öffnungen des Geräts stecken. Der Kontakt mit einem spannungsführenden Punkt oder das Kurzschließen eines Bauteils kann zu einem Brand oder elektrischen Schlag führen.
- Beim Entfernen oder Installieren eines Gerätes, nach den allgemeinen Installation Sicherheitshinweise.

## AVISO DE SEGURIDAD

Todos los productos WatchGuard están diseñados y probados para satisfacer estrictos requisitos de seguridad. Estos requisitos incluyen la homologación de productos de seguridad y otras normas de cumplimiento global. Por favor, lea atentamente las siguientes instrucciones antes de utilizar el producto, y se refieren a ellos como sea necesario para garantizar el funcionamiento seguro y continuo de su producto. Información adicional se puede encontrar en la Guía del usuario electrónica.

### Certificación de seguridad del producto

El producto tiene certificación de seguridad WatchGuard bajo las siguientes normas:

- IEC 60950-1:2005 (Second Edition)+Am 1:2009+Am 2:2013
- EN 60950-1:2006+A11+A1+A12+A2:2013
- EN 61000-3-2:2006+A1:2009+A2:2009
- EN 61000-3-3:2008

### Advertencia de seguridad

- No coloque objetos sobre el cable de alimentación.
- No obstruya las aberturas de ventilación. Estas aberturas evitan el sobrecalentamiento de la máquina.
- Nunca introduzca objetos de ningún tipo en las ranuras o aberturas del equipo. El contacto con puntos de voltaje o el cortocircuito de una pieza podría provocar un incendio o una descarga eléctrica.
- Al extraer o instalar un electrodoméstico, siga las instrucciones generales de instalación de seguridad.



# Legal and Regulatory Information

---

## Limited Hardware Warranty

---

This Limited Hardware Warranty (the “Warranty”) applies to the enclosed hardware product, not including any associated software, which is licensed pursuant to a separate end-user license agreement and warranty (the “Product”). BY USING THE PRODUCT, YOU (either an individual or a single entity) AGREE TO THE TERMS HEREOF. If you do not agree to these terms, please return this package, along with proof of purchase, to the authorized dealer from which you purchased it for a full refund. WatchGuard Technologies, Inc. (“WatchGuard”) and you agree as set forth below or on the reverse side of this card, as applicable:

1. LIMITED WARRANTY. WatchGuard warrants that upon delivery and for one (1) year thereafter (the “Warranty Period”): (a) the Product will be free from material defects in materials and workmanship, and (b) the Product, when properly installed and used for its intended purpose and in its intended operating environment, will perform substantially in accordance with WatchGuard applicable specifications.

This warranty does not apply to any Product that has been: (i) altered, repaired or modified by any party other than WatchGuard except for the replacement or inclusion of specified components authorized in, and performed in strict accordance with, documentation provided by WatchGuard; or (ii) damaged or destroyed by force majeure events, accidents, power spikes or similar events, or by any intentional, reckless or negligent acts or omissions of any party. You may have additional warranties with respect to the Product from the manufacturers of Product components. However, you agree not to look to WatchGuard for, and hereby release WatchGuard from any liability for, performance of, enforcement of, or damages or other relief on account of, any such warranties or any breach thereof.

2. REMEDIES. If any Product does not comply with the WatchGuard warranties set forth in Section 1 above, WatchGuard will, following the receipt of the product you claim is defective and at its option, either (a) repair the Product, or (b) replace the Product with a like or similar product; provided, that you will be responsible for returning the Product and for all costs of shipping and handling. Repair or replacement of the Product shall not extend the Warranty Period. Any Product, component, part or other item replaced by WatchGuard becomes the property of WatchGuard. WatchGuard shall not be responsible for return of or damage to any software, firmware, information or data contained in, stored on, or integrated with any returned Products.

3. DISCLAIMER AND RELEASE. THE WARRANTIES, OBLIGATIONS AND LIABILITIES OF WATCHGUARD, AND YOUR REMEDIES, SET FORTH IN PARAGRAPHS 1 AND 2 ABOVE ARE EXCLUSIVE AND IN SUBSTITUTION FOR, AND YOU HEREBY WAIVE, DISCLAIM AND RELEASE ANY AND ALL OTHER WARRANTIES, OBLIGATIONS AND LIABILITIES OF WATCHGUARD AND ALL OTHER RIGHTS, CLAIMS AND REMEDIES YOU MAY HAVE AGAINST WATCHGUARD, EXPRESS OR IMPLIED, ARISING BY LAW OR OTHERWISE, WITH RESPECT TO ANY NONCONFORMANCE OR DEFECT IN THE PRODUCT (INCLUDING, BUT NOT LIMITED TO, ANY IMPLIED

WARRANTY OF MERCHANTABILITY OR FITNESS FOR A PARTICULAR PURPOSE, ANY IMPLIED WARRANTY ARISING FROM COURSE OF PERFORMANCE, COURSE OF DEALING, OR USAGE OF TRADE, ANY WARRANTY OF NONINFRINGEMENT, ANY WARRANTY OF UNINTERRUPTED OR ERROR-FREE OPERATION, ANY OBLIGATION, LIABILITY, RIGHT, CLAIM OR REMEDY IN TORT, WHETHER OR NOT ARISING FROM THE NEGLIGENCE (WHETHER ACTIVE, PASSIVE OR IMPUTED) OR FAULT OF WATCHGUARD OR FROM PRODUCT LIABILITY, STRICT LIABILITY OR OTHER THEORY, AND ANY OBLIGATION, LIABILITY, RIGHT, CLAIM OR REMEDY FOR LOSS OR DAMAGE TO, OR CAUSED BY OR CONTRIBUTED TO BY, THE PRODUCT).

4. LIMITATION AND LIABILITY. WATCHGUARD'S LIABILITY (WHETHER ARISING IN CONTRACT (INCLUDING WARRANTY), TORT (INCLUDING ACTIVE, PASSIVE OR IMPUTED NEGLIGENCE AND STRICT LIABILITY AND FAULT) OR OTHER THEORY) WITH REGARD TO ANY PRODUCT WILL IN NO EVENT EXCEED THE PURCHASE PRICE PAID BY YOU FOR SUCH PRODUCT. THIS SHALL BE TRUE EVEN IN THE EVENT OF THE FAILURE OF ANY AGREED REMEDY. IN NO EVENT WILL WATCHGUARD BE LIABLE TO YOU OR ANY THIRD PARTY (WHETHER ARISING IN CONTRACT (INCLUDING WARRANTY), TORT (INCLUDING ACTIVE, PASSIVE OR IMPUTED NEGLIGENCE AND STRICT LIABILITY AND FAULT) OR OTHER THEORY) FOR COST OF COVER OR FOR ANY INDIRECT, SPECIAL, INCIDENTAL, OR CONSEQUENTIAL DAMAGES (INCLUDING WITHOUT LIMITATION LOSS OF PROFITS, BUSINESS, OR DATA) ARISING OUT OF OR IN CONNECTION WITH THIS WARRANTY OR THE USE OF OR INABILITY TO USE THE PRODUCT, EVEN IF WATCHGUARD HAS BEEN ADVISED OF THE POSSIBILITY OF SUCH DAMAGES. THIS SHALL BE TRUE EVEN IN THE EVENT OF THE FAILURE OF ANY AGREED REMEDY.

5. MISCELLANEOUS PROVISIONS. This Warranty will be governed by the laws of the state of Washington, U.S.A., without reference to its choice of law rules. The provisions of the 1980 United Nations Convention on Contracts for the International Sales of Goods, as amended, shall not apply. You agree not to directly or indirectly transfer the Product or use of the product or associated documentation to any country to which such transfer would be prohibited by the U.S. Export laws and regulations. If any provision of this Warranty is found to be invalid or unenforceable, then the remainder shall have full force and effect and the invalid provision shall be modified or partially enforced to the maximum extent permitted by law to effectuate the purpose of this Warranty. This is the entire agreement between WatchGuard and you relating to the Product, and supersedes any prior purchase order, communications, advertising or representations concerning the Product AND BY USING THE PRODUCT YOU AGREE TO THESE TERMS. IF THE PRODUCT IS BEING USED BY AN ENTITY, THE INDIVIDUAL INDICATING AGREEMENT TO THESE TERMS BY USING THE PRODUCT REPRESENTS AND WARRANTS THAT (A) SUCH INDIVIDUAL IS DULY AUTHORIZED TO ACCEPT THE WARRANTY ON BEHALF OF THE ENTITY AND TO BIND THE ENTITY TO THE TERMS OF THIS WARRANTY; (B) THE ENTITY HAS THE FULL POWER, CORPORATE OR OTHERWISE, TO ENTER INTO THE WARRANTY AND PERFORM ITS OBLIGATIONS UNDER THE WARRANTY AND; (C) THE WARRANTY AND THE PERFORMANCE OF THE ENTITY'S OBLIGATIONS UNDER THE WARRANTY DO NOT VIOLATE ANY THIRD-PARTY AGREEMENT TO WHICH THE ENTITY IS A PARTY. No change or modification of the Warranty will be valid unless it is in writing and is signed by WatchGuard.

All WatchGuard products are designed and tested to meet strict safety requirements. These requirements include product safety approvals and other global compliance standards. Please read the following instructions carefully before operating the product, and refer to them as needed to ensure the continued safe operation of your product. Additional information can be found in the electronic Hardware Guide.

# Declaration of Conformity

## Declaration of Conformity

WatchGuard Technologies Inc. hereby declares that the product(s) listed below conform to the European Union directives and standards identified in this declaration.

**Product (s):**

Wireless Access Point, WatchGuard Model AP320

**EU Directive(s):**

Radio & Télécommunications Terminal Equipment (1999/5/EC)  
 Low Voltage (2006/95/EC)  
 Electromagnetic Compatibility (2004/108/EC)  
 Energy-related Products (2009/125/EC)  
 RoHS (2002/95/EC)  
 WEEE Directive 2002/96/EC  
 The Radio Equipment Directive (2014/53/EU)

**Common Standard(s):**

EN 60950-1:2006+A11+A1+A12+A2:2013	Safety for ITE
EN 55022:2010/AC:2011	Class B Emissions for ITE
EN 55024:2010	Immunity for ITE
EN 55032:2012/AC:2013	
EN 62311:2008	
EN 50385:2002	
EN 61000-3-2:2014	Harmonics
EN 61000-3-3:2013	Flicker

**Wireless Standard(s):**

EN 301 489-01 v2.1.1	EMC and Radio Spectrum Matters
EN 301 489-17 v3.1.1	EMC and Radio Spectrum Matters
EN 300 328 v2.1.1	Radio Spectrum Matters
EN 301 893 v2.2.0	Broadband Radio Access Networks

**This device complies with Directive 2014/53/EU issued by the Commission of the European Community.**

Manufacturer / Hersteller: WatchGuard Technologies  
 505 5th Ave S. Suite 500, Seattle, WA 98104 USA

Radio Equipment / Funkanlage:	Wireless Access Point
Type Designation / Typenbezeichnung:	AP320
Specifications / Technische Daten:	802.11a,b,g,n,ac (2.4Ghz & 5Ghz)
Intended Purpose / Verwendungszweck:	Indoor Access Point
Equipment Class / Betriebsmittel der Klasse:	Class II

The above device complies with the essential requirements and other relevant provisions to Directive 2014/53/EU when used for its intended purpose. This equipment may be operated in the USA, Canada, & Europe Union.

**Warning!** This is a Class B product. In a domestic environment this product may cause radio interference in which case the user may be required to take adequate measures.

The frequency and maximum transmitted power limit in EU are listed as follows,

2412 - 2472 MHz: 20 dBm  
 5150 - 5350 MHz: 23 dBm  
 5250 - 5350 MHz: 30 dBm  
 5470 - 5725 MHz: 30 dBm

**Restrictions: France** (i) les dispositifs fonctionnant dans la bande 5150-5250 MHz sont réservés uniquement pour une utilisation à l'intérieur afin de réduire les risques de brouillage préjudiciable aux systèmes de satellites mobiles utilisant les mêmes canaux; (ii) De plus, les utilisateurs devraient aussi être avisés que les utilisateurs de radars de haute puissance sont désignés utilisateurs principaux (c.-à-d., qu'ils ont la priorité) pour les bandes 5 250-5 350 MHz et 5 650-5 850 MHz et que ces radars pourraient causer du brouillage et/ou des dommages aux dispositifs LAN-EL. Die oben genannten Gerät entspricht den grundlegenden Anforderungen und anderen relevanten Bestimmungen der Richtlinie 2014/53/EU, wenn für den vorgesehenen Zweck verwendet werden. Dieses Gerät ist für die Verwendung in den USA, Kanada, and Europäische Union.

**Warning!** Dies ist eine Einrichtung der Klasse B. Diese Einrichtung kann im Wohnbereich Funkstörungen verursachen. In diesem Fall kann vom Betreiber verlangt werden, angemessene Maßnahmen durchzuführen  
**Einschränkungen: Frankreich** –(i)-Geräte, die im Band 5150-5250 MHz ist nur für den Innenbereich, um das Risiko von Störungen des mobilen Satelliten-Systeme, die die gleichen Kanäle (ii) Darüber hinaus reduzieren vorbehalten, sollten Benutzer auch darauf hingewiesen werden, dass die Nutzer von Hochleistungs-Radare bezeichnet werden primäre Benutzer (dh d. sie haben Priorität) der Bänder 5 250-5 350 MHz und 5 650-5 850 MHz und dass diese Radargeräte können Störungen und / oder Schäden an LE-LAN-Geräten verursachen.

Laurence Huang

Signature  
 Full Name: Laurence Huang  
 Position: Manufacturing Program Manager



Date: May 23, 2017

## FCC Certification

---

This device complies with part 15 of the FCC Rules. Operation is subject to the following two conditions: (1) This device may not cause harmful interference, and (2) this device must accept any interference received, including interference that may cause undesired operation.

This device has been tested and found to comply with the limits for a Class B digital device, pursuant to Part 15 of the FCC Rules. These limits are designed to provide reasonable protection against harmful interference in a residential installation. This equipment generates uses and can radiate radio frequency energy and, if not installed and used in accordance with the instructions, may cause harmful interference to radio communications. However, there is no guarantee that interference will not occur in a particular installation if this equipment does cause harmful interference to radio or television reception, which can be determined by turning the equipment off and on, the user is encouraged to try to correct the interference by one or more of the following measures:

- Reorient or relocate the receiving antenna.
- Increase the separation between the equipment and receiver.
- Connect the equipment into an outlet on a circuit different from that to which the receiver is connected.
- Consult the dealer or an experienced radio/TV technician for help.

\* FCC Caution: Any changes or modifications not expressly approved by the party responsible for compliance could void the user's authority to operate this equipment.

This transmitter must not be co-located or operating in conjunction with any other antenna or transmitter.

For operation within 5.15 ~ 5.25GHz / 5.47 ~5.725GHz frequency range, it is restricted to indoor environment. The band from 5600-5650MHz will be disabled by the software during the manufacturing and cannot be changed by the end user. This device meets all the other requirements specified in Part 15E, Section 15.407 of the FCC Rules.

### IMPORTANT NOTE:

#### FCC Radiation Exposure Statement:

This equipment complies with FCC radiation exposure limits set forth for an uncontrolled environment. This equipment should be installed and operated with minimum distance 24cm between the radiator & your body.

Note: The country code selection is for non-US model only and is not available to all US model. Per FCC regulation, all WiFi product marketed in US must fixed to US operation channels only.

Dieses Gerät wurde getestet und entspricht den Grenzwerten für ein Digitalgerät der Klasse B gemäß Teil 15 der Federal Communications Commission (FCC) Regeln einhalten. Diese Grenzwerte sollen einen angemessenen Schutz vor schädlichen Störungen, wenn das Gerät in einer kommerziellen Umgebung betrieben wird. Dieses Gerät erzeugt, verwendet und kann Hochfrequenzenergie abstrahlen, und wenn nicht installiert und in Übereinstimmung mit der Bedienungsanleitung, kann es Störungen im Funkverkehr verursachen. Der Betrieb dieses Gerätes in einem Wohngebiet wird wahrscheinlich schädliche Interferenzen in dem Fall muss der Benutzer die Störungen auf seine / ihre eigene Kosten zu beheben.



## CE Notice

---

The CE symbol on your WatchGuard Technologies equipment indicates that it is in compliance with the Electromagnetic Compatibility (EMC) directive and the Low Voltage Directive (LVD) of the European Union (EU).



This equipment should be installed and operated with minimum distance 24cm between the radiator & your body.

## Industry Canada Certification

---

This device complies with ISED's licence-exempt RSSs. Operation is subject to the following two conditions: (1) This device may not cause harmful interference, and (2) this device must accept any interference received, including interference that may cause undesired operation.

Le présent appareil est conforme aux CNR d'ISED applicables aux appareils radio exempts de licence. L'exploitation est autorisée aux deux conditions suivantes : (1) le dispositif ne doit pas produire de brouillage préjudiciable, et (2) ce dispositif doit accepter tout brouillage reçu, y compris un brouillage susceptible de provoquer un fonctionnement indésirable.

Caution :

- (i) the device for operation in the band 5150-5250 MHz is only for indoor use to reduce the potential for harmful interference to co-channel mobile satellite systems;
- (ii) the maximum antenna gain permitted for devices in the bands 5250-5350 MHz and 5470-5725 MHz shall be such that the equipment still complies with the e.i.r.p. limit;
- (iii) the maximum antenna gain permitted for devices in the band 5725-5850 MHz shall be such that the equipment still complies with the e.i.r.p. limits specified for point-to-point and non-point-to-point operation as appropriate; and
- (iv) the worst-case tilt angle(s) necessary to remain compliant with the e.i.r.p. elevation mask requirement set forth in Section 6.2.2(3) shall be clearly indicated.
- (v) Users should also be advised that high-power radars are allocated as primary users (i.e. priority users) of the bands 5250-5350 MHz and 5650-5850 MHz and that these radars could cause interference and/or damage to LE-LAN devices.

Avertissement:

Le guide d'utilisation des dispositifs pour réseaux locaux doit inclure des instructions précises sur les restrictions susmentionnées, notamment :

- (i) les dispositifs fonctionnant dans la bande 5150-5250 MHz sont réservés uniquement pour une utilisation à l'intérieur afin de réduire les risques de brouillage préjudiciable aux systèmes de satellites mobiles utilisant les mêmes canaux;
- (ii) le gain maximal d'antenne permis pour les dispositifs utilisant les bandes de 5250 à 5350 MHz et de 5470 à 5725 MHz doit être conforme à la limite de la p.i.r.e;

(iii) le gain maximal d'antenne permis (pour les dispositifs utilisant la bande de 5 725 à 5 850 MHz) doit être conforme à la limite de la p.i.r.e. spécifiée pour l'exploitation point à point et l'exploitation non point à point, selon le cas;

(iv) les pires angles d'inclinaison nécessaires pour rester conforme à l'exigence de la p.i.r.e. applicable au masque d'élévation, et énoncée à la section 6.2.2 3), doivent être clairement indiqués.

(v) De plus, les utilisateurs devraient aussi être avisés que les utilisateurs de radars de haute puissance sont désignés utilisateurs principaux (c.-à-d., qu'ils ont la priorité) pour les bandes 5250-5350 MHz et 5650-5850 MHz et que ces radars pourraient causer du brouillage et/ou des dommages aux dispositifs LAN-EL.

Radiation Exposure Statement:

This equipment complies with ISED radiation exposure limits set forth for an uncontrolled environment. This equipment should be installed and operated with minimum distance 24cm between the radiator & your body.

Déclaration d'exposition aux radiations:

Cet équipement est conforme aux limites d'exposition aux rayonnements ISED établies pour un environnement non contrôlé. Cet équipement doit être installé et utilisé avec un minimum de 24cm de distance entre la source de rayonnement et votre corps.

## Europe – EU Declaration of Conformity (Wireless)

This device complies with the essential requirements of the RED Directive 2013/53/EU. The following test methods have been applied in order to prove presumption of conformity with the essential requirements of the RED Directive 2013/53/EU:

**-EN60950-1/A12:2011+A2:2013**

Safety of Information Technology Equipment

**-EN 50385:2002**

Product standard to demonstrate the compliance of radio base stations and fixed terminal stations for wireless telecommunication systems with the basic restrictions or the reference levels related to human exposure to radio frequency electromagnetic fields (110MHz - 40 GHz) - General public

**-EN 300 328 V1.8.1:2012**

Electromagnetic compatibility and Radio spectrum Matters (ERM); Wideband transmission systems; Data transmission equipment operating in the 2.4GHz ISM band and using wide band modulation techniques; Harmonized EN covering the essential requirements of article 3.2 of the RED Directive

**-EN 301 893 V1.7.1:2012**

Broadband Radio Access Networks (BRAN); 5GHz high performance RLAN; Harmonized EN covering the essential requirements of article 3.2 of the RED Directive

**-EN 301 489-1 V1.9.2:2011**

Electromagnetic compatibility and Radio spectrum Matters (ERM); Electro Magnetic Compatibility (EMC) standard for radio equipment and services; Part 1: Common technical requirements

**-EN 301 489-17 V2.2.1:2012**

Electromagnetic compatibility and Radio spectrum Matters (ERM); ElectroMagnetic Compatibility (EMC) standard for radio equipment; Part 17: Specific conditions for Broadband Data Transmission Systems















This device is a 5GHz wideband transmission system (transceiver), intended for use in all EU member states and EFTA countries, except in France and Italy where restrictive use applies.



In Italy the end-user should apply for a license at the national spectrum authorities in order to obtain authorization to use the device for setting up outdoor radio links and/or for supplying public access to telecommunications and/or network services.

This device may not be used for setting up outdoor radio links in France and in some areas the RF output power may be limited to 10 mW EIRP in the frequency range of 2454 - 2483.5 MHz. For detailed information the end-user should contact the national spectrum authority in France.



AT	BE	BG	CZ	DK
EE	FR	DE	IS	IE
IT	EL	ES	CY	LV
LI	LT	LU	HU	MT
NL	NO	PL	PT	RO
SI	SK	TR	FI	SE
CH	UK	HR		

 Český [Czech]	WatchGuard Technologies tímto prohlašuje, že tento AP320 je ve shodě se základními požadavky a dalšími příslušnými ustanoveními směrnice 1999/5/ES.
 Dansk [Danish]	Undertegnede WatchGuard Technologies erklærer herved, at følgende udstyr AP320 overholder de væsentlige krav og øvrige relevante krav i direktiv 1999/5/EF.
 Deutsch [German]	Hiermit erklärt WatchGuard Technologies, dass sich das Gerät AP320 in Übereinstimmung mit den grundlegenden Anforderungen und den übrigen einschlägigen Bestimmungen der Richtlinie 1999/5/EG befindet.
 Eesti [Estonian]	Käesolevaga kinnitab WatchGuard Technologies seadme AP320 vastavust direktiivi 1999/5/EÜ põhinõuetele ja nimetatud direktiivist tulenevatele teistele asjakohastele sätetele.
 English	Hereby, WatchGuard Technologies, declares that this AP320 is in compliance with the essential requirements and other relevant provisions of Directive 1999/5/EC.
 Español [Spanish]	Por medio de la presente WatchGuard Technologies declara que el AP320 cumple con los requisitos esenciales y cualesquiera otras disposiciones aplicables o exigibles de la Directiva 1999/5/CE.
 Ελληνική [Greek]	ΜΕ ΤΗΝ ΠΑΡΟΥΣΑ WatchGuard Technologies ΔΗΛΩΝΕΙ ΟΤΙ ΑΡ320 ΣΥΜΜΟΡΦΩΝΕΤΑΙ ΠΡΟΣ ΤΙΣ ΟΥΣΙΩΔΕΙΣ ΑΠΑΙΤΗΣΕΙΣ ΚΑΙ ΤΙΣ ΛΟΙΠΕΣ ΣΧΕΤΙΚΕΣ ΔΙΑΤΑΞΕΙΣ ΤΗΣ ΟΔΗΓΙΑΣ 1999/5/ΕΚ.
 Français [French]	Par la présente WatchGuard Technologies déclare que l'appareil AP320 est conforme aux exigences essentielles et aux autres dispositions pertinentes de la directive 1999/5/CE.
 Italiano [Italian]	Con la presente WatchGuard Technologies dichiara che questo AP320 è conforme ai requisiti essenziali ed alle altre disposizioni pertinenti stabilite dalla direttiva 1999/5/CE.
Latviski [Latvian]	Ar šo WatchGuard Technologies deklarē, ka AP320 atbilst Direktīvas 1999/5/EK būtiskajām prasībām un citiem ar to saistītajiem noteikumiem.
Lietuvių [Lithuanian]	Šiuo WatchGuard Technologies deklaruoja, kad šis AP320 atitinka esminius reikalavimus ir kitas 1999/5/EB Direktyvos nuostatas.
 Nederlands [Dutch]	Hierbij verklaart WatchGuard Technologies dat het toestel AP320 in overeenstemming is met de essentiële eisen en de andere relevante bepalingen van richtlijn 1999/5/EG.
 Malti [Maltese]	Hawnhekk, WatchGuard Technologies, jiddikjara li dan AP320 jikkonforma mal-ftigijiet essenzjali u ma provvedimenti oħrajn relevanti li hemm fid-Dirrettiva 1999/5/EC.
 Magyar [Hungarian]	Alulírott, WatchGuard Technologies nyilatkozom, hogy a AP320 megfelel a vonatkozó alapvető követelményeknek és az 1999/5/EC irányelv egyéb előírásainak.
 Polski [Polish]	Niniejszym WatchGuard Technologies oświadcza, że AP320 jest zgodny z zasadniczymi wymogami oraz pozostałymi stosownymi postanowieniami Dyrektywy 1999/5/EC.
 Português [Portuguese]	WatchGuard Technologies declara que este AP320 está conforme com os requisitos essenciais e outras disposições da Directiva 1999/5/CE.

 Slovensko [Slovenian]	WatchGuard Technologies izjavlja, da je ta AP320 v skladu z bistvenimi zahtevami in ostalimi relevantnimi določili direktive 1999/5/ES.
Slovensky [Slovak]	WatchGuard Technologies týmto vyhlasuje, že AP320 spĺňa základné požiadavky a všetky príslušné ustanovenia Smernice 1999/5/ES.
 Suomi [Finnish]	WatchGuard Technologies vakuuttaa täten että AP320 tyyppinen laite on direktiivin 1999/5/EY oleellisten vaatimusten ja sitä koskevien direktiivin muiden ehtojen mukainen.
 Svenska [Swedish]	Härmed intygar WatchGuard Technologies att denna AP320 står i överensstämmelse med de väsentliga egenskapskrav och övriga relevanta bestämmelser som framgår av direktiv 1999/5/EG.

## RoHS Statement

The member states of the European Union approved directive 2002/95/EC, Restrictions of Hazardous Substances (“RoHS directive”) that became valid on July 1, 2006. It states that all new electrical and electronic equipment put on the market within the member states must not contain certain hazardous materials. This device complies with the European Union’s RoHS directive 2002/95/EC and similar regulations that may be adopted by other countries for European Sales.

## WEEE Statement

WEEE is a general set of requirements dictated in the EU Directive 2002/96/EC. This Directive mandated that member EU countries enact regulations governing the Waste of Electrical and Electronic Equipment (WEEE). The Directive, and its individual transpositions into specific country laws and legislation, is aimed at the reduction of WEEE through reuse, recovery, and recycling of WEEE.

WatchGuard is working in partnership with our European Union (EU) distribution partners to ensure that our products are in compliance with the WEEE statutes, and that the recovery of our product per the specific EU country legislative requirements is seamless for our product’s end users. If you have a WatchGuard product that is at its end of life and needs to be disposed of, please contact WatchGuard Customer Care Department at:

U.S. Customers: 877.232.3531

International Customers: +1.206.613.0456

WatchGuard is reasonably confident that our products do not contain any substances or hazardous materials presently banned by any legislation, and do not present a risk due to hazardous materials. WEEE recovery professionals should also note that these products do not have any materials that are of particular high value in their individual form.

## REACH Certificate of Compliance

---

The new EU chemicals policy REACH (Registration, Evaluation, Authorization and restriction of Chemicals) came into effect on June 1, 2007. REACH is Europe's new chemicals legislation, which is applicable in all 27 EU Member States as well as the EFTA European Economic Area (EEA). REACH creates a new system for gathering information, assessing risks to human health and the environment, and authorizing or restricting the marketing and use of chemicals produced or supplied in the EEA. REACH has an impact on EEA producers and importers of finished products and users of chemicals in the course of industrial or professional activities.

WatchGuard supports the overall REACH objective of improving the protection of human health and the environment and will meet all applicable REACH requirements. WatchGuard is strongly committed to working with our customers and supply chain to define and implement the REACH requirements and ensure a smooth transition to compliance.

One of the REACH requirements is that manufacturers and importers have the duty to register substances they are producing or importing. In accordance with the regulations, the products of WatchGuard do not need to be registered for the following reasons:

- WatchGuard does not import more than 1 metric ton per year of a substance as defined by REACH.
- WatchGuard products are non-chemical products that are not designed to release any substance under normal and reasonably predictable application.
- Our products do not contain the listed substances at more than 0.1% by weight of the whole product/part.

## Taiwan Class B Notice

---

警告使用者：這是乙類產品，應使用並正確安裝。本產品可能會造成無線電干擾，在這種情況下，用戶可能需要採取適當的措施。

警示 本電池如果更換不正確會有爆炸的危險，請勿自行更換電池

## Taiwan NCC

---

低功率電波輻射性電機管理辦法

第十二條 經型式認證合格之低功率射頻電機，非經許可，公司、商號或使用者均不得擅自變更頻率、加大功率或變更原設計之特性及功能。

第十四條 低功率射頻電機之使用不得影響飛航安全及干擾合法通信；經發現有干擾現象時，應立即停用，並改善至無干擾時方得繼續使用。前項合法通信，指依電信法規定作業之無線電通信。低功率射頻電機須忍受合法通信或工業、科學及醫療用電波輻射性電機設備之干擾。在 5.25-5.35 兆赫頻帶內操作之無線資訊傳輸設備，限於室內使用。

## Japan VCCI Notice (Class B ITE)

---

この装置は、クラス B 情報技術装置です。この装置は、家庭環境で使用することを目的としていますが、この装置がラジオやテレビジョン受信機に近接して使用されると、受信障害を引き起こすことがあります。取扱説明書に従って正しい取り扱いをして下さい。VCCI-B

# GNU General Public License (GPL)

---

Version 2, June 1991  
Copyright © 1989, 1991 Free Software Foundation, Inc.  
51 Franklin Street, Fifth Floor  
Boston, MA 02110-1301, USA

Everyone is permitted to copy and distribute verbatim copies of this license document, but changing it is not allowed.

## Preamble

The licenses for most software are designed to take away your freedom to share and change it. By contrast, the GNU General Public License is intended to guarantee your freedom to share and change free software--to make sure the software is free for all its users. This General Public License applies to most of the Free Software Foundation's software and to any other program whose authors commit to using it. (Some other Free Software Foundation software is covered by the GNU Library General Public License instead.) You can apply it to your programs, too.

When we speak of free software, we are referring to freedom, not price. Our General Public Licenses are designed to make sure that you have the freedom to distribute copies of free software (and charge for this service if you wish), that you receive source code or can get it if you want it, that you can change the software or use pieces of it in new free programs; and that you know you can do these things.

To protect your rights, we need to make restrictions that forbid anyone to deny you these rights or to ask you to surrender the rights. These restrictions translate to certain responsibilities for you if you distribute copies of the software, or if you modify it.

For example, if you distribute copies of such a program, whether gratis or for a fee, you must give the recipients all the rights that you have. You must make sure that they, too, receive or can get the source code. And you must show them these terms so they know their rights.

We protect your rights with two steps: (1) copyright the software, and (2) offer you this license which gives you legal permission to copy, distribute and/or modify the software.

Also, for each author's protection and ours, we want to make certain that everyone understands that there is no warranty for this free software. If the software is modified by someone else and passed on, we want its recipients to know that what they have is not the original, so that any problems introduced by others will not reflect on the original authors' reputations.

Finally, any free program is threatened constantly by software patents. We wish to avoid the danger that redistributors of a free program will individually obtain patent licenses, in effect making the program proprietary. To prevent this, we have made it clear that any patent must be licensed for everyone's free use or not licensed at all.

The precise terms and conditions for copying, distribution and modification follow.

## Terms and Conditions for Copying, Distribution, and Modification

1. This License applies to any program or other work which contains a notice placed by the copyright holder saying it may be distributed under the terms of this General Public License. The "Program", below, refers to any such program or work, and a "work based on the Program" means either the Program or any derivative work under copyright law: that is to say, a work containing the Program or



a portion of it, either verbatim or with modifications and/or translated into another language. (Hereinafter, translation is included without limitation in the term "modification".) Each licensee is addressed as "you".

Activities other than copying, distribution and modification are not covered by this License; they are outside its scope. The act of running the Program is not restricted, and the output from the Program is covered only if its contents constitute a work based on the Program (independent of having been made by running the Program). Whether that is true depends on what the Program does.

2. You may copy and distribute verbatim copies of the Program's source code as you receive it, in any medium, provided that you conspicuously and appropriately publish on each copy an appropriate copyright notice and disclaimer of warranty; keep intact all the notices that refer to this License and to the absence of any warranty; and give any other recipients of the Program a copy of this License along with the Program.

You may charge a fee for the physical act of transferring a copy, and you may at your option offer warranty protection in exchange for a fee. You may modify your copy or copies of the Program or any portion of it, thus forming a work based on the Program, and copy and distribute such modifications or work under the terms of Section 1 above, provided that you also meet all of these conditions:

- You must cause the modified files to carry prominent notices stating that you changed the files and the date of any change.
- You must cause any work that you distribute or publish, that in whole or in part contains or is derived from the Program or any part thereof, to be licensed as a whole at no charge to all third parties under the terms of this License.
- If the modified program normally reads commands interactively when run, you must cause it, when started running for such interactive use in the most ordinary way, to print or display an announcement including an appropriate copyright notice and a notice that there is no warranty (or else, saying that you provide a warranty) and that users may redistribute the program under these conditions, and telling the user how to view a copy of this License. (Exception: if the Program itself is interactive but does not normally print such an announcement, your work based on the Program is not required to print an announcement.)

These requirements apply to the modified work as a whole. If identifiable sections of that work are not derived from the Program, and can be reasonably considered independent and separate works in themselves, then this License, and its terms, do not apply to those sections when you distribute them as separate works. But when you distribute the same sections as part of a whole which is a work based on the Program, the distribution of the whole must be on the terms of this License, whose permissions for other licensees extend to the entire whole, and thus to each and every part regardless of who wrote it.

Thus, it is not the intent of this section to claim rights or contest your rights to work written entirely by you; rather, the intent is to exercise the right to control the distribution of derivative or collective works based on the Program.

In addition, mere aggregation of another work not based on the Program with the Program (or with a work based on the Program) on a volume of a storage or distribution medium does not bring the other work under the scope of this License.

3. You may copy and distribute the Program (or a work based on it, under Section 2) in object code or executable form under the terms of Sections 1 and 2 above provided that you also do one of the following:
  - Accompany it with the complete corresponding machine-readable source code, which must be distributed under the terms of Sections 1 and 2 above on a medium customarily used for software interchange; or,
  - Accompany it with a written offer, valid for at least three years, to give any third party, for a charge no more than your cost of physically performing source distribution, a complete machine-readable copy of the corresponding source code, to be distributed under the terms of Sections 1 and 2 above on a medium customarily used for software interchange; or,

- Accompany it with the information you received as to the offer to distribute corresponding source code. (This alternative is allowed only for noncommercial distribution and only if you received the program in object code or executable form with such an offer, in accord with Subsection b above.)

The source code for a work means the preferred form of the work for making modifications to it. For an executable work, complete source code means all the source code for all modules it contains, plus any associated interface definition files, plus the scripts used to control compilation and installation of the executable. However, as a special exception, the source code distributed need not include anything that is normally distributed (in either source or binary form) with the major components (compiler, kernel, and so on) of the operating system on which the executable runs, unless that component itself accompanies the executable.

If distribution of executable or object code is made by offering access to copy from a designated place, then offering equivalent access to copy the source code from the same place counts as distribution of the source code, even though third parties are not compelled to copy the source along with the object code.

4. You may not copy, modify, sublicense, or distribute the Program except as expressly provided under this License. Any attempt otherwise to copy, modify, sublicense or distribute the Program is void, and will automatically terminate your rights under this License. However, parties who have received copies, or rights, from you under this License will not have their licenses terminated so long as such parties remain in full compliance.
5. You are not required to accept this License, since you have not signed it. However, nothing else grants you permission to modify or distribute the Program or its derivative works. These actions are prohibited by law if you do not accept this License. Therefore, by modifying or distributing the Program (or any work based on the Program), you indicate your acceptance of this License to do so, and all its terms and conditions for copying, distributing or modifying the Program or works based on it.
6. Each time you redistribute the Program (or any work based on the Program), the recipient automatically receives a license from the original licensor to copy, distribute or modify the Program subject to these terms and conditions. You may not impose any further restrictions on the recipients' exercise of the rights granted herein. You are not responsible for enforcing compliance by third parties to this License.
7. If, as a consequence of a court judgment or allegation of patent infringement or for any other reason (not limited to patent issues), conditions are imposed on you (whether by court order, agreement or otherwise) that contradict the conditions of this License, they do not excuse you from the conditions of this License. If you cannot distribute so as to satisfy simultaneously your obligations under this License and any other pertinent obligations, then as a consequence you may not distribute the Program at all. For example, if a patent license would not permit royalty-free redistribution of the Program by all those who receive copies directly or indirectly through you, then the only way you could satisfy both it and this License would be to refrain entirely from distribution of the Program.

If any portion of this section is held invalid or unenforceable under any particular circumstance, the balance of the section is intended to apply and the section as a whole is intended to apply in other circumstances.

It is not the purpose of this section to induce you to infringe any patents or other property right claims or to contest validity of any such claims; this section has the sole purpose of protecting the integrity of the free software distribution system, which is implemented by public license practices. Many people have made generous contributions to the wide range of software distributed through that system in reliance on consistent application of that system; it is up to the author/donor to decide if he or she is willing to distribute software through any other system and a licensee cannot impose that choice.

This section is intended to make thoroughly clear what is believed to be a consequence of the rest of this License.

8. If the distribution and/or use of the Program is restricted in certain countries either by patents or by copyrighted interfaces, the original copyright holder who places the Program under this License may add an explicit geographical distribution limitation excluding those countries, so that distribution is permitted only in or among countries not thus excluded. In such case, this License incorporates the limitation as if written in the body of this License.
9. The Free Software Foundation may publish revised and/or new versions of the General Public License from time to time. Such new versions will be similar in spirit to the present version, but may differ in detail to address new problems or concerns.  
Each version is given a distinguishing version number. If the Program specifies a version number of this License which applies to it and "any later version", you have the option of following the terms and conditions either of that version or of any later version published by the Free Software Foundation. If the Program does not specify a version number of this License, you may choose any version ever published by the Free Software Foundation.
10. If you wish to incorporate parts of the Program into other free programs whose distribution conditions are different, write to the author to ask for permission. For software which is copyrighted by the Free Software Foundation, write to the Free Software Foundation; we sometimes make exceptions for this. Our decision will be guided by the two goals of preserving the free status of all derivatives of our free software and of promoting the sharing and reuse of software generally.

## **NO WARRANTY**

1. BECAUSE THE PROGRAM IS LICENSED FREE OF CHARGE, THERE IS NO WARRANTY FOR THE PROGRAM, TO THE EXTENT PERMITTED BY APPLICABLE LAW. EXCEPT WHEN OTHERWISE STATED IN WRITING THE COPYRIGHT HOLDERS AND/OR OTHER PARTIES PROVIDE THE PROGRAM "AS IS" WITHOUT WARRANTY OF ANY KIND, EITHER EXPRESSED OR IMPLIED, INCLUDING, BUT NOT LIMITED TO, THE IMPLIED WARRANTIES OF MERCHANTABILITY AND FITNESS FOR A PARTICULAR PURPOSE. THE ENTIRE RISK AS TO THE QUALITY AND PERFORMANCE OF THE PROGRAM IS WITH YOU. SHOULD THE PROGRAM PROVE DEFECTIVE, YOU ASSUME THE COST OF ALL NECESSARY SERVICING, REPAIR OR CORRECTION.
2. IN NO EVENT UNLESS REQUIRED BY APPLICABLE LAW OR AGREED TO IN WRITING WILL ANY COPYRIGHT HOLDER, OR ANY OTHER PARTY WHO MAY MODIFY AND/OR REDISTRIBUTE THE PROGRAM AS PERMITTED ABOVE, BE LIABLE TO YOU FOR DAMAGES, INCLUDING ANY GENERAL, SPECIAL, INCIDENTAL OR CONSEQUENTIAL DAMAGES ARISING OUT OF THE USE OR INABILITY TO USE THE PROGRAM (INCLUDING BUT NOT LIMITED TO LOSS OF DATA OR DATA BEING RENDERED INACCURATE OR LOSSES SUSTAINED BY YOU OR THIRD PARTIES OR A FAILURE OF THE PROGRAM TO OPERATE WITH ANY OTHER PROGRAMS), EVEN IF SUCH HOLDER OR OTHER PARTY HAS BEEN ADVISED OF THE POSSIBILITY OF SUCH DAMAGES.

